



Math worksheet on '2D Shape Congruent or Similar - Image and Property to Image (Level 1)'. Part of a broader unit on 'Geometry - Shape Classification (2D) - Intro'

Learn online:

[app.mobius.academy/math/units/geometry\\_shapes\\_2d\\_classifying\\_intro/](http://app.mobius.academy/math/units/geometry_shapes_2d_classifying_intro/)

**2**



Which image is congruent to this shape?

**a**

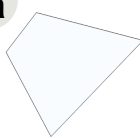

**b**



**3**

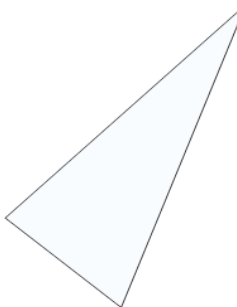

Which image is neither similar nor congruent to this shape?

**a**



**b**

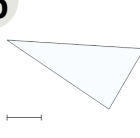

**4**

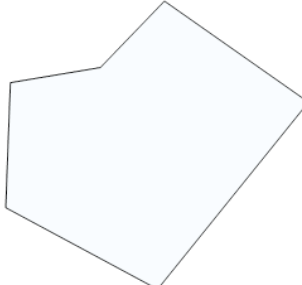

Which image is neither similar nor congruent to this shape?

**a**

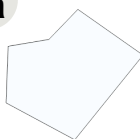

**b**

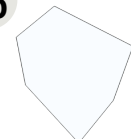

**5**

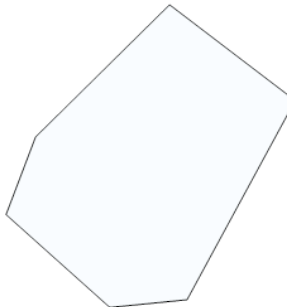

Which image is congruent to this shape?

**a**

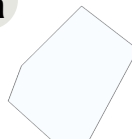

**b**



**6**

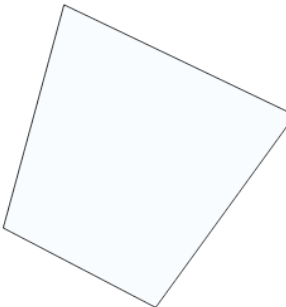

Which image is congruent to this shape?

**a**

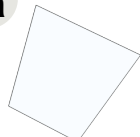

**b**

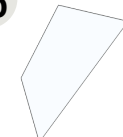

**7**

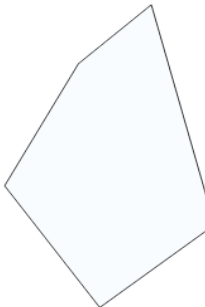

Which image is congruent to this shape?

**a**



**b**

