





Math worksheet on 'Nets of 3D Shapes - Shape Image to Net (Level 1)'. Part of a broader unit on 'Geometry - Surface Area of 3D Shapes - Intro'

Learn online:

app.mobius.academy/math/units/geometry_surface_area_basic_shapes_intro/

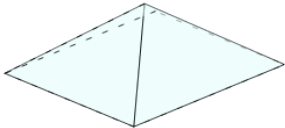

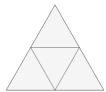
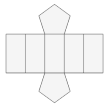
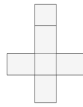

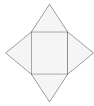
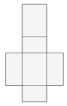

1 What net would make this 3D shape?

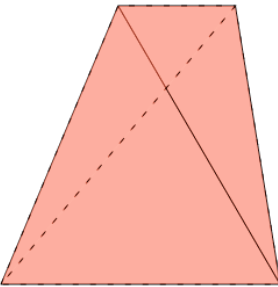

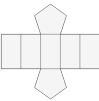
a 	b 	c 
d 	e 	f 



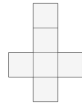

2 What net would make this 3D shape?

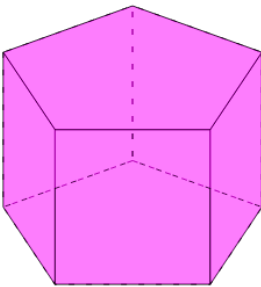

a 	b 	c 
d 	e 	f 

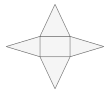

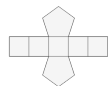
3 What net would make this 3D shape?

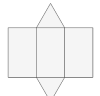

a 	b 	c 
d 	e 	f 

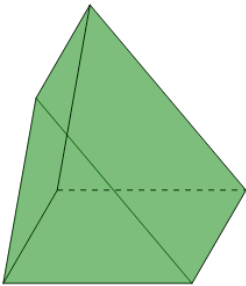

4 What net would make this 3D shape?

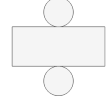
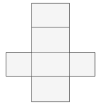
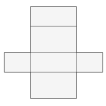
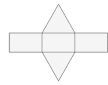

a 	b 	c 
d 	e 	f 

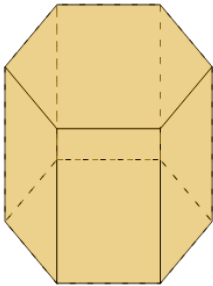

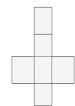
5 What net would make this 3D shape?

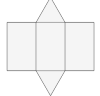
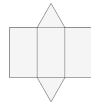
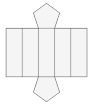
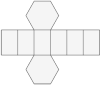

a 	b 	c 
d 	e 	f 

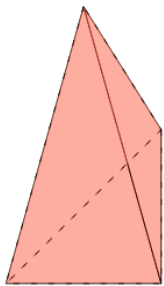

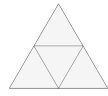
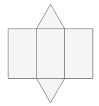
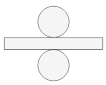
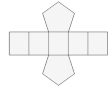

6 What net would make this 3D shape?

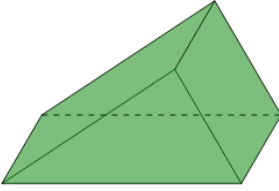

a 	b 	c 
d 	e 	f 

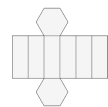
7 What net would make this 3D shape?

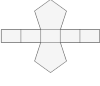
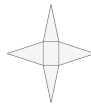

a 	b 	c 
d 	e 	f 